



**PYLONTECH**



# **Lithium-Ion Phosphate Energy Storage System Force-H2 Operation Manual**

Information Version: 2.2  
20P2FH0301



This manual introduces Force-H2 from Pylontech. Force-H2 is a high voltage Lithium-Ion Phosphate Battery storage system. Please read this manual before you install the battery and follow the instruction carefully during the installation process. Any confusion, please contact Pylontech immediately for advice and clarification.

## Content

<b>1. SAFETY.....</b>	<b>1</b>
1.1 Symbol.....	1
Symbol in label.....	1
1.2 Before Connecting.....	4
1.3 In Using.....	4
<b>2. SYSTEM INTRODUCE.....</b>	<b>5</b>
2.1 Product Introduce.....	5
2.2 Specifications.....	5
2.2.1 The parameter of system.....	6
2.2.2 Battery Module (FH48074).....	7
2.2.3 Control Module FC0500M-40 (internal power supply).....	8
LED Indicators Instructions.....	9
Definition of RJ45 Port Pin.....	12
2.3 System Diagram.....	12
<b>3. INSTALLATION.....</b>	<b>13</b>
3.1 Tools.....	13
3.2 Safety Gear.....	13
3.3 System Working Environments Checking.....	14
3.3.1 Cleaning.....	14
3.3.2 Temperature.....	14
3.3.3 Fire-extinguisher System.....	14
3.3.4 Grounding System.....	14
3.4 Handling and placement.....	14
3.4.1 Handling and placement of the battery module.....	14
3.4.2 Handling and placement of the base.....	14
3.4.3 Selection of installation sites.....	14
3.4.4 Mounting and installation of the base.....	15
3.4.5 Battery Modules and Control Module (BMS) pile up.....	16
3.4.6 Installation of the metal bracket for the system.....	17
3.4.7 Locking of the control Module's fix screw of left and right side.....	19
3.5 Cables connection.....	19
3.5.2 Cables.....	21
3.5.3 System turns on.....	22
3.5.4 System turns off.....	24

<b>4. SYSTEM DEBUG.....</b>	<b>25</b>
<b>5. MAINTENANCE.....</b>	<b>26</b>
5.1 Trouble Shooting:.....	26
5.2 Replacement of main component.....	28
5.2.1 Replacement of Battery Module.....	28
5.2.2 Replacement of Control Module (BMS).....	30
5.3 Battery Maintenance.....	30
<b>6. STORAGE RECOMMENDATIONS.....</b>	<b>32</b>
<b>7. SHIPMENT.....</b>	<b>32</b>
<b>ANNEX 1: INSTALLATION AND SYSTEM TURN ON PROGRESS LIST.....</b>	<b>33</b>
<b>ANNEX 2: SYSTEM TURN OFF PROGRESS LIST.....</b>	<b>34</b>

# 1. Safety

The Force-H2 is a high voltage DC system, operated by skilled/qualified personnel only. Read all safety instructions carefully prior to any work and observe them at all times when working on with the system.

**Incorrect operation or work may cause:**





- injury or death to the operator or a third party;
- damage to the system hardware and other properties belonging to the operator or a third party.





**Skills of Qualified Personnel**





Qualified personnel must have the following skills:

- training in the installation and commissioning of the electrical system, as well as the dealing with hazards;
- knowledge of this manual and other related documents;
- knowledge of the local regulations and directives.

**1.1 Symbol**

	<p><b>Danger</b></p>	<p><b>Lethal voltage!</b></p> <ul style="list-style-type: none"> <li>● Battery strings will produce HIGH DC power and can cause a lethal voltage and an electric shock.</li> <li>● Only qualified person can perform the wiring of the battery strings.</li> </ul>
	<p><b>Warning</b></p>	<p><b>Risk of battery system damage or personal injury</b></p> <ul style="list-style-type: none"> <li>● DO not pull out the connectors while the system is working!</li> <li>● De-energize from all multiple power sources and verify that there is no voltage.</li> </ul>
	<p><b>Caution</b></p>	<p><b>Risk of battery system failure or life cycle reduces.</b></p>
	<p><b>Symbol in label</b></p>	<p><b>Read the product and operation manual before operating the battery system!</b></p>

	Symbol in label	<b>Danger! Safety!</b>
	Symbol in label	<b>Warning electric shock!</b>
	Symbol in label	<b>Do not place near flammable material</b>
	Symbol in label	<b>Do not reverse connection the positive and negative.</b>
	Symbol in label	<b>Do not place near open flame</b>
	Symbol in label	<b>Do not place at the children and pet touchable area.</b>
	Symbol in label	<b>Recycle label.</b>
	Symbol in label	<b>Label for Waste Electrical and Electronic Equipment (WEEE) Directive (2012/19/EU)</b>

	<p>Symbol in label</p>	<p><b>The certificate label for EMC.</b></p>
	<p>Symbol in label</p>	<p><b>The certificate label for Safety by TÜV SÜD.</b></p>
	<p>Symbol in label</p>	<p><b>The certificate label for Safety by TÜV Rheinland.</b></p>
	<p>Symbol in label</p>	<p><b>The certificate label for Safety by TÜV Rheinland.</b></p>



**Danger:** Batteries deliver electric power, resulting in burns or a fire hazard when they are short circuited, or wrongly installed.

**Danger:** Lethal voltages are present in the battery terminals and cables. Severe injuries or death may occur if touch the cables and terminals.



**Warning:** DO NOT open or deform the battery module, otherwise the product will be out of warranty scope

**Warning:** Whenever working on the battery, wear suitable personal protective equipment (PPE) such as rubber gloves, rubber boots and goggles.

**Warning:** Force-H2 system working temperature range: 0°C ~ 50°C; Optimum temperature: 18°C ~ 28°C. Out of the working temperature range may cause the battery system over / low temperature alarm or protection which further lead to the cycle life reduction as well as. It will affect the warranty terms as well.



**Warning:** For battery installation, the installer shall refer to NFPA70 or similar local installation standard for operation.



**Caution:** Improper settings or maintenance can permanently damage the battery.

**Caution:** Incorrect inverter parameters will lead to a further faulty/damage to battery.

## Reminding



- 1) It is very important and necessary to read the user manual carefully (in the accessories) before installing or using battery. Failure to do so or to follow any of the instructions or warnings in this document can result in electrical shock, serious injury, or death, or can damage battery, potentially rendering it inoperable.
- 2) If the battery is stored for long time, it is required to charge them every six months, and the SOC should be no less than 90%;
- 3) Battery needs to be recharged within 12 hours, after fully discharged;
- 4) Do not expose cable outside;



### 1.2 Before Connecting

- 1) After unpacking, please check product and packing list first, if product is damaged or lack of parts, please contact with the local retailer;
- 2) Before installation, be sure to cut off the grid power and make sure the battery is in the switched-off mode;
- 3) Wiring must be correct, do not mistake the positive and negative cables, and ensure no short circuit with the external device;
- 4) It is prohibited to connect the battery and AC power directly;
- 5) Battery system must be well ground and the resistance must be less than 100mΩ;
- 6) Please ensured the electrical parameters of battery system are compatible to related equipment;
- 7) Keep the battery away from water and fire.



### 1.3 In Using

- 1) If the battery system needs to be moved or repaired, the power must be cut off and the battery is completely shut down;
- 2) It is prohibited to connect the battery with different type of battery.
- 3) It is prohibited to put the batteries working with faulty or incompatible inverter;
- 4) It is prohibited to disassemble the battery (QC tab removed or damaged);
- 5) In case of fire, only dry powder fire extinguisher can be used, liquid fire extinguishers are prohibited;



## 2. System Introduce

### 2.1 Product Introduce

Force-H2 is a high voltage battery storage system based on lithium iron phosphate battery, which is one of the new energy storage products developed and produced by Pylontech. It can be used to support reliable power for various types of equipment and systems. Force-H2 is especially suitable for those application scenes which required high power output, limited installation space, restricted load-bearing and long cycle life.

### 2.2 Specifications



## 2.2.1 The parameter of system

Product Type	Force-H2		
Cell Technology	Li-iron (LFP)		
Battery System Capacity(kWh)	7.10	10.65	14.20
Battery System Voltage(Vdc)	192	288	384
Battery System Capacity(AH)	37Ah		
Battery Controller Name	FC0500M-40S		
Battery Module Name	FH9637M		
Battery Module Quantity(pcs)	2	3	4
Battery Module Capacity(kWh)	3.552		
Battery Module Voltage(Vdc)	96		
Battery Module Capacity(AH)	37		
Battery System Charge Upper-Voltage(Vdc)	174	261	348
Battery System Charge Current(Amps, Standard)	7.4		
Battery System Charge Current(Amps, Normal)	18.5		
Battery System Charge Current(Amps, Max.@15s)	40		
Battery System Discharge lower-Voltage(Vdc)	216	324	432
Battery System Discharge Current(Amps, Standard)	7.4		
Battery System Discharge Current(Amps, Normal)	18.5		
Battery System Discharge Current(Amps, Max.@15s)	40		
Short circuit rating(Amps)	<4000		
Efficiency(%)	96		
Depth of Discharge(%)	90		
Dimension(W*D*H, mm)	450*296*822	450*296*1118	450*296*1414
Communication	CANBUS/Modbus RTU		
Protection Class	IP55		
Weight(kg)	82	117	152
Operation Life(Years)	15+		
Operation Temperature(°C)	0~50°C		
Storage Temperature(°C)	-20~60°C		
Humidity	5~95%		
Product Certificate	VDE2510-50, IEC62619, IEC62477-1, IEC62040-1, CEC, CE		
Transfer Certificate	UN38.3		
1) Battery Controller Dimensions(W*D*H)	450×296×190 mm		
2) Battery Module Dimensions (W*D*H)	450×296×296mm		
3) Battery bottom base Dimensions(W*D*H)	450×296×40 mm		

## 2.2.2 Battery Module (FH48074)



Product Type	FH9637M
Cell Technology	Li-ion (LFP)
Battery Module Capacity (kWh)	3.552
Battery Module Voltage (Vdc)	96
Battery Module Capacity (Ah)	37
Battery Module Serial Cell Quantity (pcs)	30
Battery Cell Voltage (Vdc)	3.2
Battery Cell Capacity (AH)	37
Dimension (W*D*H, mm)	450*296*296
Weight (kg)	35
Operation Life	15+Years
Operation Cycle Life	5,000
Operation Temperature	0~50°C
Storage Temperature	-20~60°C
Transfer Certificate	UN38.3

### 2.2.3 Control Module FC0500M-40 (internal power supply)



#### Control Module (FC0500-40) Display Panel



#### LED Button

	Short Press	Display the LED panel for 20sec.
	Long Press (more than 5sec)	When status LED fast flashes blue ●, loss the button, then it is 115200 baud rate of RS485.
		When status LED fast flashes orange ●, loss the button, then it is 9600 baud rate of RS485.

#### Status



2 colors, Blue and orange  
Refer to [LED Indicators Instructions]

### Battery Module Status

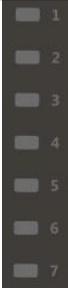
	Blue solid	Normal
	Orange solid	Individual module alarm or protection. See trouble shooting steps in section 5.1



### System Capacity



System SOC  
Each LED indicate 25%SOC

Indicate the system SOC.

### LED Indicators Instructions

Condition			Note
Self-checking	Blue, Flashing	All flashing	
Self-checking failure	Orange, Slow flashing	Off	Battery Module Status off. See trouble shooting steps in section 5.1
Black start success	Blue, fast flashing	Off	
Black start failure	Orange, Fast flashing	Off	See trouble shooting steps in section 5.1
Communication Lost or BMS error	Orange, solid	Indicate SOC, blue, solid	See trouble shooting steps in section 5.1
Idle	Blue, slow flashing	Indicate SOC, blue, solid	
Charge	Blue, solid	Indicate SOC, blue, solid	
Floating charge	Blue, solid	All flashing, horse race lamp	
Discharge	Blue, flashing	Indicate SOC, blue, solid	
System sleep	Blue, flashing	Off	Battery module status off

**Remark:** Slow flashing: 2.0s ON/1.0s OFF. Flashing 0.5s ON/0.5s OFF.

Fast flashing: 0.1s ON/0.1s OFF.

### Control Module (FC0500M-40S) Cable Panel

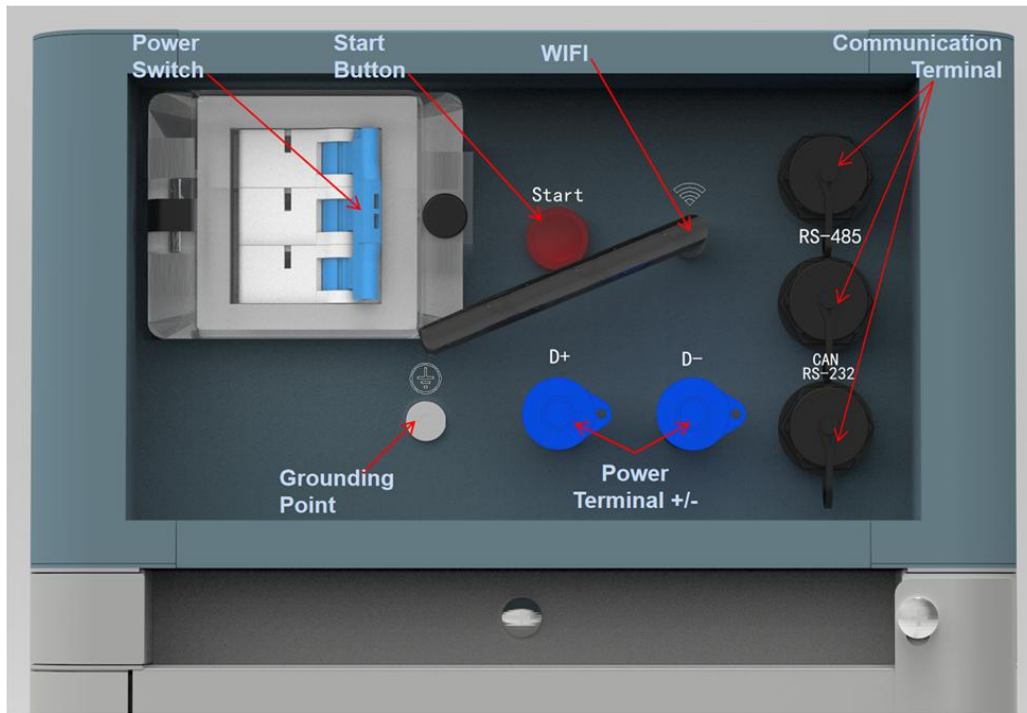

#### Power Switch

ON: main breaker ON, able to turn on battery system by start button.  
OFF: system turn off completely, no power output.



**Caution:** When the breaker is tripped off because of over current or short circuit, must wait more than 30min then can turn on it again, otherwise may cause the breaker damage.

#### Start

Start function: press more than 5sec until the buzzer rings, to turn on controller.



开机: 长按至蜂鸣器响

**Power on:** Press and hold  $\geq 5\text{sec}$  till the buzzer rings

Black start function: when system turn on, and relay is OFF, press more than 10sec, and relay will turn on for 10 min without communication(depends on conditions).

#### WiFi

Manufacturer: Pylon Technologies Co., Ltd.

Address: Plant 8, No.505 Kunkai Road, JinXi Town, 215324 Kunshan City, Jiangsu Province,  
PEOPLE'S REPUBLIC OF CHINA

Importer: XXXX (Located in installed country)

Address: XXXX (Located in installed country)

Wireless maximum output power: 20dBm

Operating frequency: 2412-2472MHz

Gain of antenna: Max 3dBi

Modulation system:

DBPSK/DQPSK/CCK(DSSS)

BPSK/QPSK/16QAM/64QAM(OFDM)

Modulating Repetition:

1Mbps/2Mbps/5.5Mbps/11Mbps(DSSS)

6Mbps/9 Mbps/12 Mbps/18 Mbps/24 Mbps/36 Mbps/48 Mbps/54 Mbps(OFDM)

MCS0~MCS7(802.11n 20MHz)

Channel spacing:5MHZ

Type of antenna: 2.4G IPEX-SMA Antenna

### **Power Terminal (+/-)**

Connect power cables of battery system with Inverter.

### **Communication Terminal (RS485 / CAN / RS232)**

RS485 Communication Terminal: (RJ45 port) follow MODBUS 485 protocol, for communication between battery system and inverter.

CAN Communication Terminal: (RJ45 port) follow CAN protocol, for communication between battery system and inverter.

RS232 Communication Terminal: (RJ45 port) for manufacturer or professional engineer to debug or service.

### Definition of RJ45 Port Pin

No.	CAN	RS485	RS232
1	---	---	---
2	GND	---	---
3	---	---	TX
4	CANH	---	---
5	CANL	---	---
6	---	---	RX
7	---	RS485A	---
8	---	RS485B	---

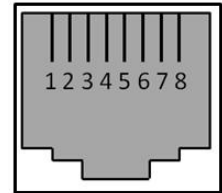

RJ45 Port



RJ45 Plug

### 2.3 System Diagram

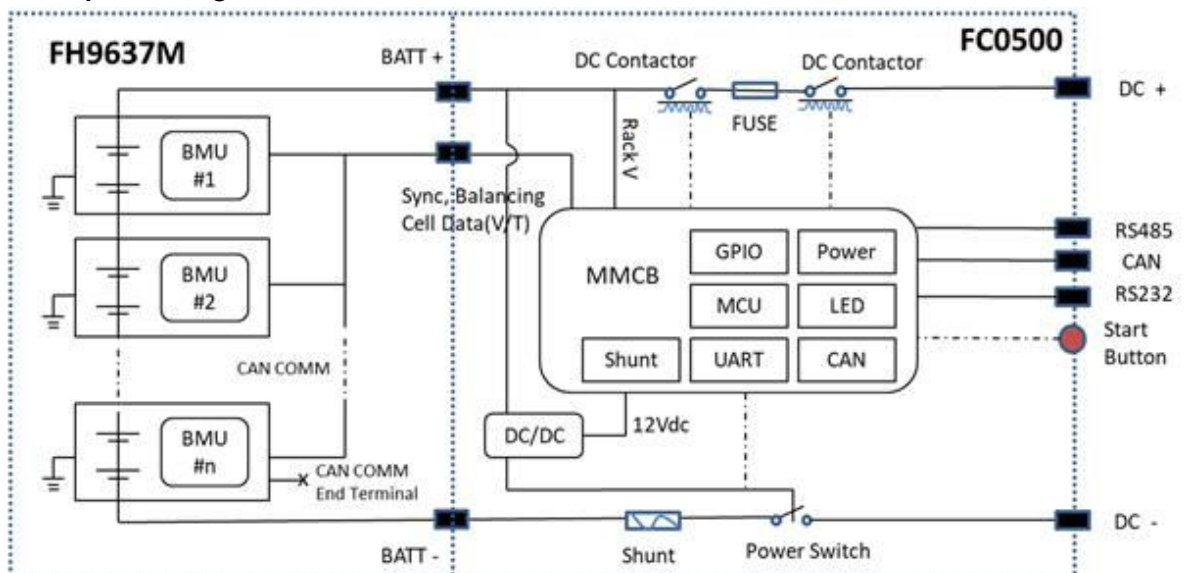



### 3. Installation

#### 3.1 Tools

The following tools are required to install the battery pack:

 <p>Wire Cutter</p>	 <p>Crimping Modular Plier</p>	 <p>Cable Ties</p>
 <p>Screw Driver Set</p>	 <p>Electric Screw Driver</p>	 <p>600VDC Multimeter</p>
 <p>Adjustable Wrench</p>	 <p>Sleeve Piece</p>	

#### NOTE

Use properly insulated tools to prevent accidental electric shock or short circuits.

If insulated tools are not available, cover the entire exposed metal surfaces with available insulated alternatives, except their tips, with electrical tape.

#### 3.2 Safety Gear

It is recommended to wear the following safety gear when dealing with the battery pack



Insulated gloves



Safety goggles



Safety shoes

### 3.3 System Working Environments Checking

#### 3.3.1 Cleaning



Before installation and system power on, the dust and iron scurf must be removed to keep a clean environment.

The system cannot be installed in desert area without an enclosure to prevent from sand.



**Danger:** Battery module has active DC power at terminal all the time), must be careful to handle the modules.

#### 3.3.2 Temperature



Force-H2 system working temperature range: 0°C~50°C; Optimum temperature: 18°C~28°C.

**Caution:** Force-H2 system is IP55 design. But please avoid frost or direct sunlight. Out of the working temperature range will cause the battery system over / low temperature alarm or protection which further lead to the cycle life reduction. According to the environment, the cooling system or heating system should be installed if it is necessary.

#### 3.3.3 Fire-extinguisher System



It must be equipped with fire-extinguisher system for safety purpose.

The fire system needs to be regularly checked to be in normal condition. Refer to the using and maintenance requirements please follow local fire equipment guidance.

#### 3.3.4 Grounding System



Before the battery installation must make sure the grounding point of the basement is stable and reliable. If the battery system is installed in an independent equipment cabin (e.g. container), must make sure the grounding of the cabin is stable and reliable.

**The resistance of the grounding system must  $\leq 100m\Omega$**

### 3.4 Handling and placement



**Warning:** The battery pile's power terminals are high voltage DC. It must be installed in a restricted access area;

**Warning:** Force-H2 is a high voltage DC system, operated by qualified and authorized personnel only.

#### 3.4.1 Handling and placement of the battery module



Single battery module is 36kg. If without handling tools must have more than 2 men to handling with it.

#### 3.4.2 Handling and placement of the base

The base is light, single person can handle with it.

#### 3.4.3 Selection of installation sites

A. Force-H2 system working temperature range: 0°C~50°C; Optimum temperature: 18°C~28°C.

Do not place the battery system in direct sun light. It is suggested to build sunshade equipment. In cold area the heating system is required.

B. Force-H2 system must not be immersed in water. Can not be placed the battery base in rain or other water sources. As a suggestion, the base's height should >300mm above the ground.

C. The base's weight capacity should support the weight of whole battery system (130~300kg).

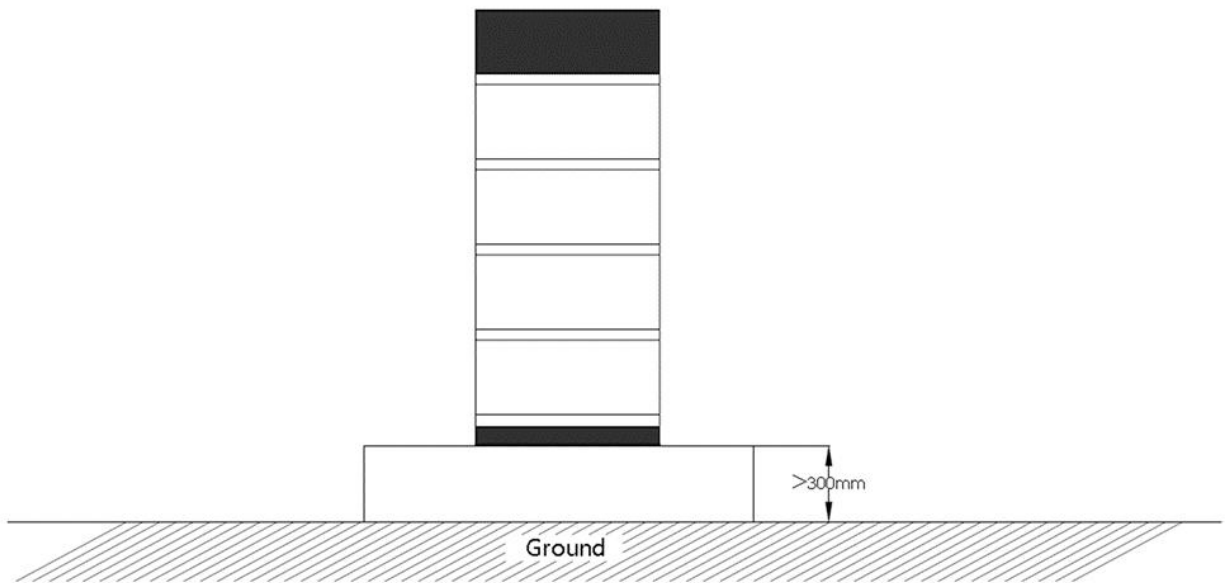

#### 3.4.4 Mounting and installation of the base

The base must be fixed installed on the basement with 4pcs M8×80 foundation bolts.

**Battery rack basement holes bitmap (unit: mm):**

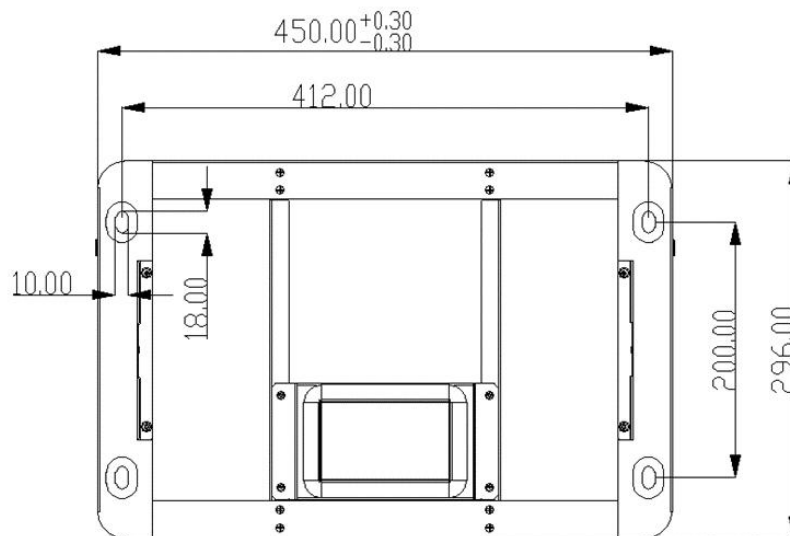

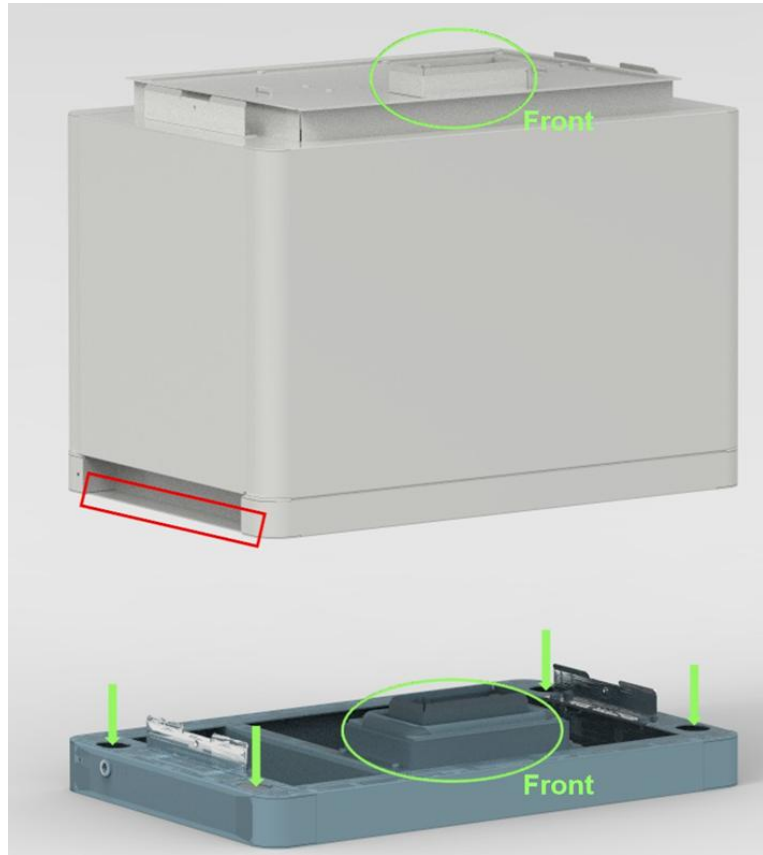

### 3.4.5 Battery Modules and Control Module (BMS) pile up

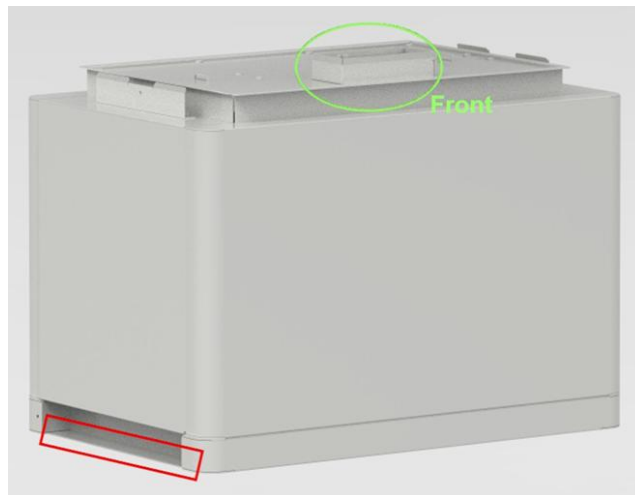

Handle above the red marked edgings of the both side of these battery modules and control module (BMS).

**Caution:** If hands under this red marked side, hands will get hurt.





**Danger:** when battery is connected together with the base the internal socket still have high voltage DC power from serial connected battery modules (battery module can't be turned off).

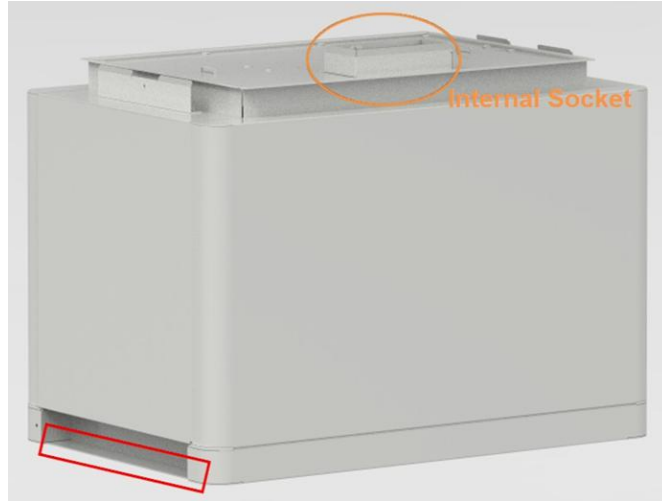

#### 3.4.6 Installation of the metal bracket for the system

In control module's package has 2pcs short and 2pcs long metal bracket s.

Fix these metal brackets at the both back side corners.

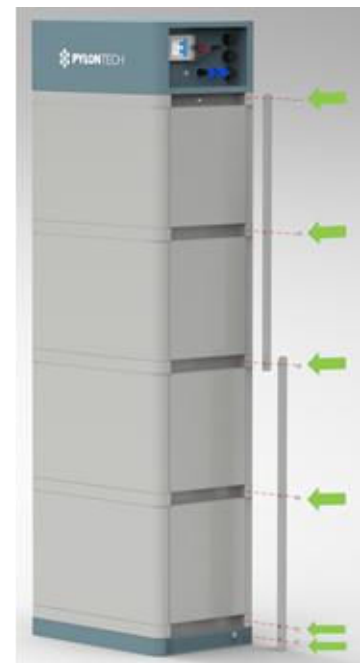

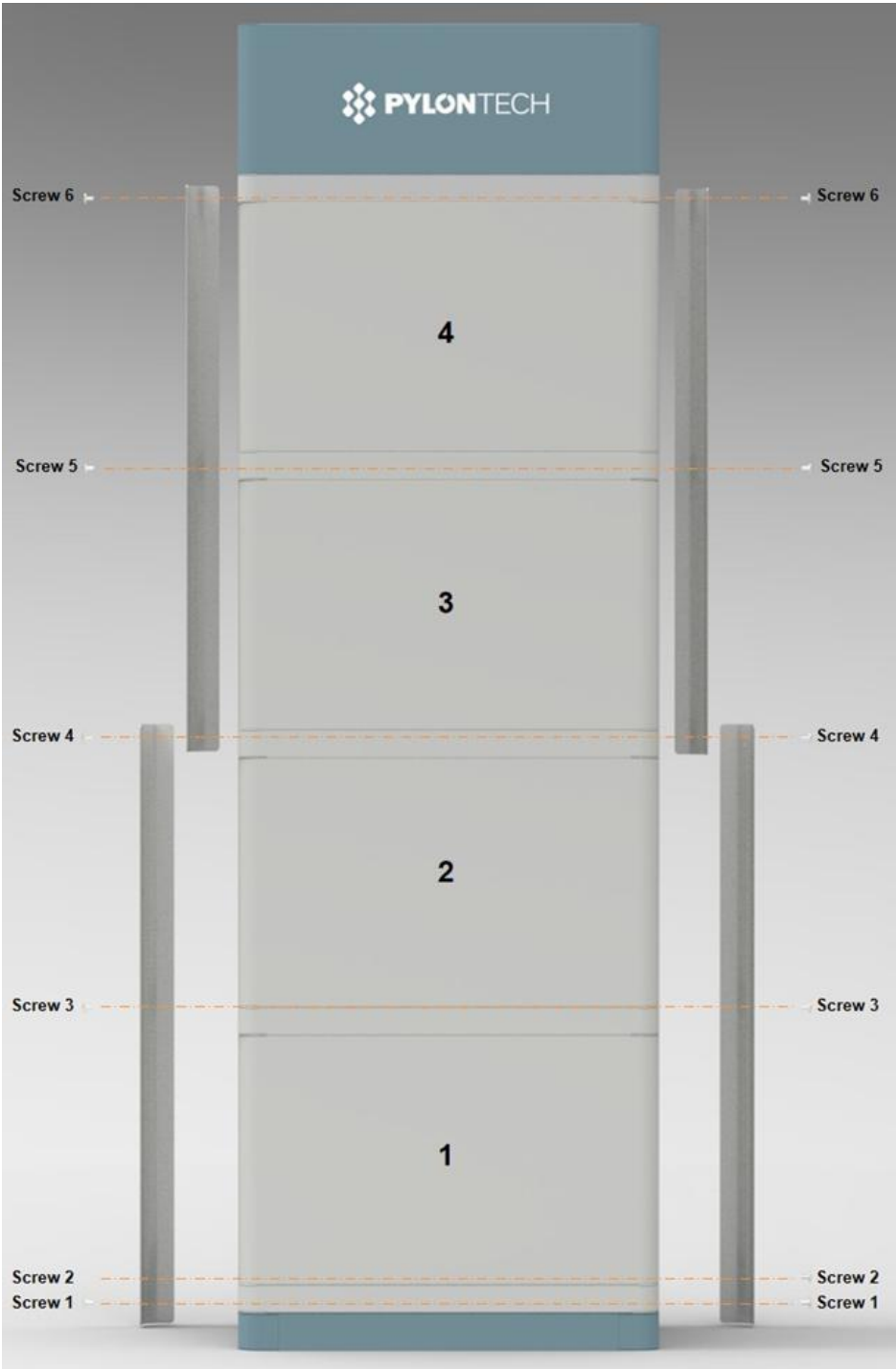



### 3.4.7 Locking of the control Module's fix screw of left and right side



### 3.5 Cables connection

#### Attention:



**Danger:** The battery system is high voltage DC system. Must make sure the grounding is fixed and reliable.

**Danger:** All the plugs and sockets of the power cables must be not reverse connection. Otherwise it will cause personal injury.

**Danger:** No short circuit or reserved connection of the battery system's positive and negative



port.

**Caution:** Wrong communication cables connection will cause the battery system failure.

### 3.5.1 Grounding

The Force-H2 modules has 3 grounding point

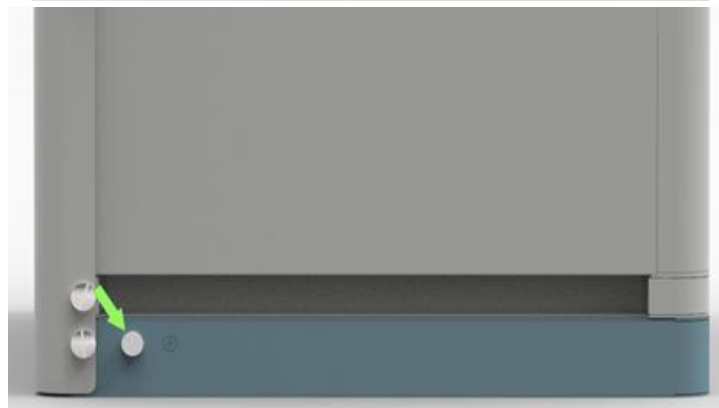
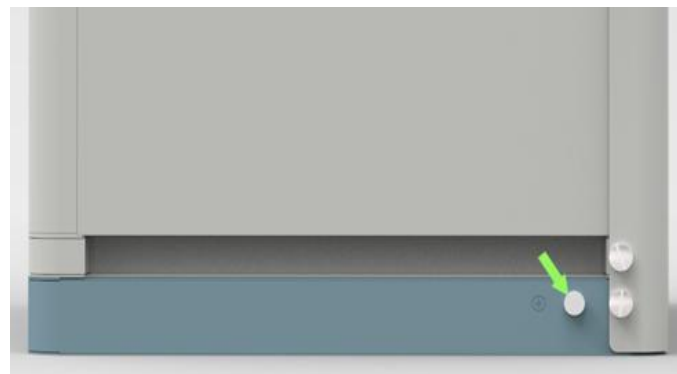

**Grounding cable must  $\geq 10$ AWG. The cable shall be copper with yellow-green color.**



### 3.5.2 Cables

**Note:** Power cable uses water-proofed connectors.

To disconnect, a special tool is required. Do not pull out directly



**Note:** Communication cable uses RJ45 connector and water-proofed cover(M19-RJ45) matched with controller connection port.

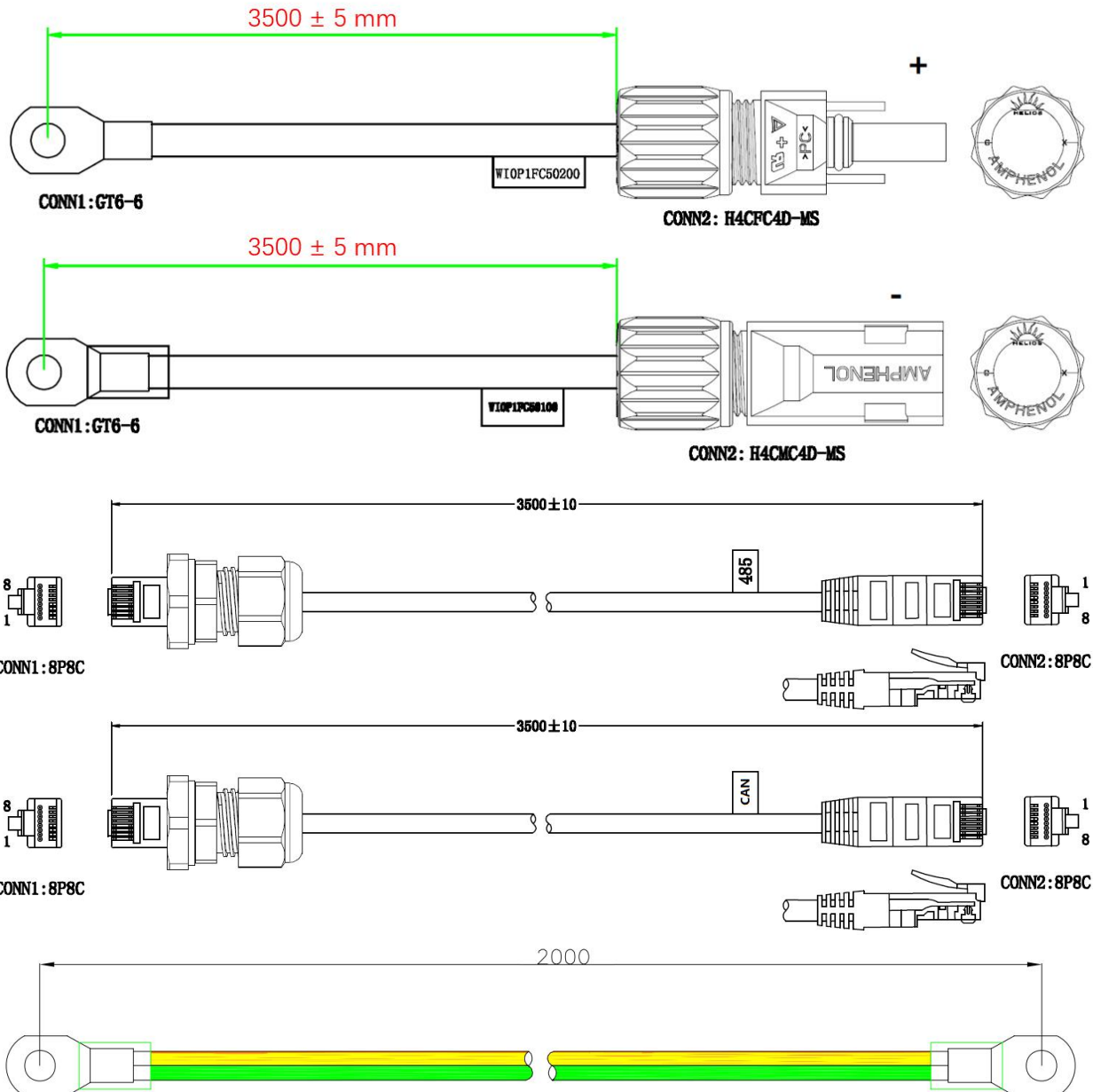

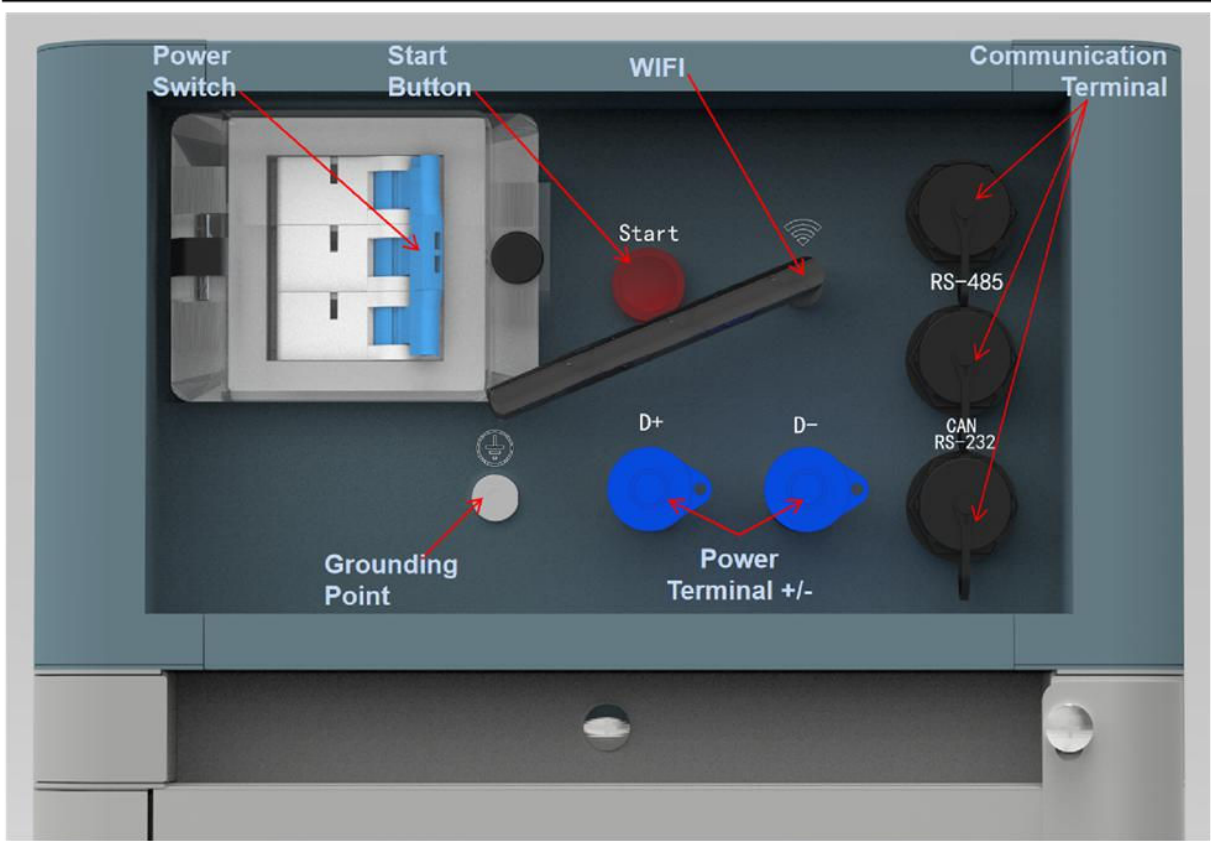

### 3.5.3 System turns on



Warning: Double check all the power cables and communication cables. Make sure the voltage of the inverter/PCS is same level with the battery system before connection. Check all the power switch are OFF.



System turns on step:

- 1) Check all cables are connected correctly. Check grounding is connected.
- 2) If necessary, turn on the switch at inverter's battery side or between inverter and battery. If possible, turn on AC or PV power source to wake up inverter.
- 3) Open protect cover of Power switch. And turn on power switch.
- 4) Press start button for at least 5 seconds or until buzzer rings. Battery takes 10-30s for self-checking.

If inverter is turned on by AC or PV source, then most inverter can setup communication with BMS automatically, in this case, the BMS will close relay and system is ready for work.

If inverter needs battery power to turn on, then check the LED of battery shall be:

Status: Orange, solid

SOC: blue, solid

In this case, press the Start button for at least 10s, till the Status lighting Blue and fast flashing,

then battery will black start to support inverter and after inverter turned on and set up communication, then BMS is ready for work.



**Caution:** When the breaker is tripped off because of over current or short circuit, must wait after 10min to turn on it again, otherwise may cause the breaker damage.



**Warning:** If has failure during the self-check, must debug the failure then can start next step.

If the "STATUS" lamp shows orange from beginning, it means there has some failure in the battery string, the Power Relays in BMS will open, must debug at first.

**Note:** The LED lamp will be off in 20sec without any operation.



**Caution:** During first time power on, the system will require to do fully charge progress for SOC calibration purpose.

**Caution:** it is suggested to fully charge the whole Battery Energy Storage System (BESS) first after installation or after long time storage without charging. Depending on the soc level, there will be a regularly (3 month) fully charge requesting during continuous operation as well, it will be handled automatically by the communication between BESS and external device.

### 3.5.4 System turns off

When failure or before service, must turn the battery storage system off:

- (1) Turn off inverter or power supply on DC side.
- (2) Turn off the switch between PCS and battery system.
- (3) Turn off the "Power Switch" of the BMS.

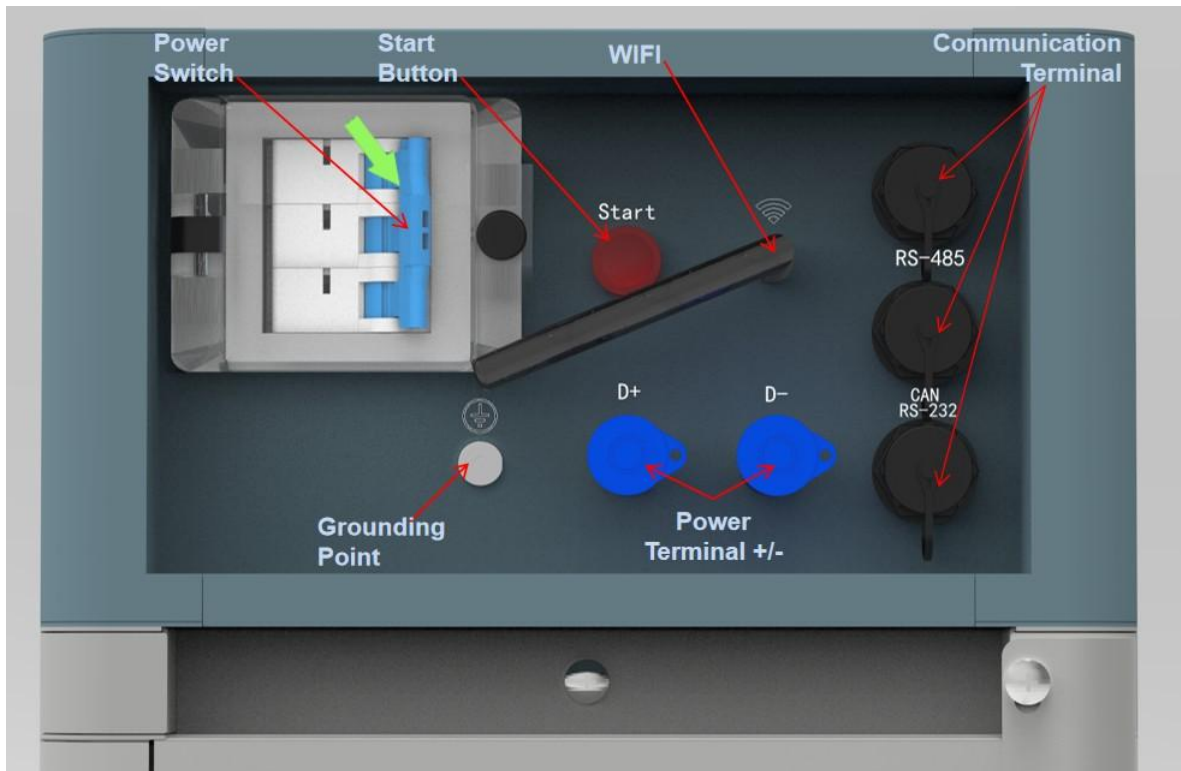

**Caution:** Before replace the battery module for service, must charge/discharge the existing battery module voltage similar to the replacement. Otherwise the system need long time to do the balance for this replaced battery module.

#### NOTE

**After installation, DO NOT forget to register online for full warranty:**

[www.pylontech.com.cn/service/support](http://www.pylontech.com.cn/service/support)

## 4. System Debug

This system debug is for BESS system (Battery Energy Storage System). BESS system can't do the debug itself. It must operation with configured inverter, UPS, PCS and EMS system together.

Debug Step	Content
Prepare of debug.	Turn on the BESS system, refer to chapter 3. Before turn on the whole BESS system turn on the load is <b>not allowed!</b> Remark: Except the BESS, if other equipment have its own system turn on step, must follow the operation manual.
Working together with inverter	<ol style="list-style-type: none"><li>1) Check the communication cable connection and make sure the cable order on battery and inverter side are matched. All undefined pin are suggested to be empty.</li><li>2) Check the baud rate of inverter. The default of battery CAN is 500kbps, MODBUS 485 is 9600bps. If necessary, change the baud rate of RS485.</li><li>3) Check the terminal resistance CAN 120 <math>\Omega</math>, 485 120 <math>\Omega</math></li><li>4) If necessary, check the setting on inverter or control box has right parameter and brand of battery. And check the information of BESS shown on inverter is correct.</li></ol>

## 5. Maintenance

### 5.1 Trouble Shooting:



**Danger:** The Force-H2 is a high voltage DC system, operated by qualified and authorized person only.

**Danger:** Before check the failure, must check all the cables connection and the BESS system can turn on normally or not.

Check the environment first

No	Problem	Possible Reason	Solution
1	No power output, no led on.	Press start button too short.	To turn on, at least 5s To black start, at least 10s.
		The button battery in controller is missing or failure. The power supply in controller is failure	Change the controller module.
		The battery voltage is too low.	Make sure at least 2 battery modules.
		The connector of base is failure	The base is not connected or change the base
2	After turned on, status LED slow flashing orange. Others off.	Self-checking failure. DC side has a voltage, but voltage difference with the battery system is higher than 20V.	Make sure no DC voltage or set correct DC voltage before press start button. Then follow turn on process.
		BMS internal failure.	Use debug tool to further analysis or change the controller module.
3	Status LED fast flashing orange, others off.	The time interval after last time black start is too short.	Wait more than 5 minutes and try black start again.
		The battery system under error condition such as: temperature or current protection or other error, thus do not response black start.	Make sure no other protection factor. Or use debug tool to further analysis.
4	Buzzer rings continue	Relay adhesion or failure.	Completely disconnect battery system with any DC source then make a restart. If problem remain, then swap the controller.
5	Status LED solid orange. Battery module LED blue solid.	Communication lost with inverter	Check the communication cable PIN and wiring whether is correctly.

		Over current protection.	Check DC side. And wait until BMS release protection.
		Controller failure.	Use debug tool to further analysis or change the controller module. Or use debug tool.
6	Status LED solid orange. Battery module exists LED in orange solid	Over/ under temperature protection.	Check environment temperature. And wait BMS release.
		Over voltage protection.	Check DC charge voltage setting or wait BMS release.
		Under voltage protection.	Use black start function, and then charge the system.
		Battery module BMS failure	Use debug tool to further analysis or change the battery module.
7	All LED blue but no output.	Fuse fusing	Change the controller module
8	Other failure	Cell failure or electrical board failure. Or failure need debug tool for further debug.	Can't find out failure point or can't check. Please contact with distributor or Pylontech.

Once a certain failure detected following the trouble shooting steps, shut down the battery string first before replacement to avoid further over discharge to the system due to the self-consumption.

## 5.2 Replacement of main component



**Danger:** The Force-H2 is a high voltage DC system, operated by qualified and authorized person only.

**Danger:** Before replace the main component must shut off the maintenance battery string's power. Must confirm the **D+** and **D-** terminal are without power. The turn off progress refer to chapter 3.6.5.

### 5.2.1 Replacement of Battery Module

5.2.1.1 Charge existing module to full (SOC 100%). Make sure new battery module is 100% as well.

5.2.1.2 Turn off the whole battery string's power. Must confirm the **D+** and **D-** terminal are without power. The turn off progress refer to chapter 3.6.5.

5.2.1.3 Dismantle **D+** and **D-** Power Cable, Communication Cable and Grounding Cable.

5.2.1.4 Dismantle the control Module's fix screw of left and right side. And dismantle the fix metal brackets.



5.2.1.5 Move the control module and each battery module one by one.



**Danger:** when battery is connected together with the base the internal socket still have high voltage DC power from serial connected battery modules (battery module can't be turned off).



Handle above the red marked edgings of the both side of these battery modules and control module (BMS).

**Caution:** If hands under this red marked side, hands will get hurt.







**Warning:** Single battery module is 35kg. If without handling tools must more than 2 men to handling with it.

5.2.1.6 Pile up the new battery module. And pile up the battery modules and control module up again.

5.2.1.7 Install back the control Module's fix screw of left and right side. And Install back the fix metal brackets.

5.2.1.8 Install back Grounding Cable, Communication Cable and the **D+** and **D-** Power Cable.

5.2.1.9 Turn on this battery string. Refer to chapter 3.6.

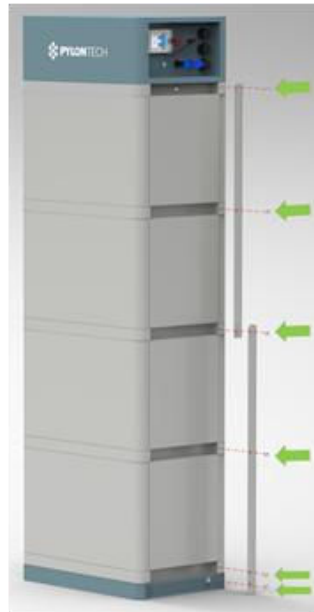

## 5.2.2 Replacement of Control Module (BMS)

5.2.2.1 Turn off the whole battery string's power. Must confirm the **D+** and **D-** terminal are without power. The turn off progress refer to chapter 3.6.5.

5.2.2.2 Dismantle **D+** and **D-** Power Cable, Communication Cable and Grounding Cable.

5.2.2.3 Dismantle the control Module's fix screw of left and right side. And dismantle the fix metal brackets.

5.2.2.4 Remove the control module.



**Danger:** when battery is connected together with the base the internal socket still have high voltage DC power from serial connected battery

modules (battery module can't be turned off).

5.2.2.5 Pile up the new control module.

5.2.2.6 Install back the control Module's fix screw of left and right side. And Install back the fix metal brackets.

5.2.2.7 Install back Grounding Cable, Communication Cable and the **D+** and **D-** Power Cable.

5.2.2.8 Turn on this battery string. Refer to chapter 3.6.



## 5.3 Battery Maintenance

**Danger:** The maintenance of battery must be done by qualified and authorized personnel only.

**Danger:** Some maintenance items must turn off at first.

### 5.3.1 Voltage Inspection:

**[Periodical Maintenance]** Check the voltage of battery system through the monitor system. Check the system whether exist abnormal voltage or not. For example: Single cell's voltage is abnormal high or low.

### 5.3.2 SOC Inspection:

**[Periodical Maintenance]** Check the SOC of battery system through the monitor system. Check the battery string whether exist abnormal SOC or not.

### 5.3.3 Cables Inspection:

**[Periodical Maintenance]** Visual inspect all the cables of battery system. Check the cables has broken, aging, getting loose or not.

### 5.3.4 Balancing:

**[Periodical Maintenance]** The battery strings will become unbalance if long time not be full

charged. Solution: every 3 month should do the balancing maintenance (charge to full), normally it will be done automatically by the communication between system and external device.

#### **5.3.5 Output Relay Inspection:**

**[Periodical Maintenance]** Under low load condition (low current), control the output relay OFF and ON to hear the relay has click voice, that's mean this relay can off and on normally.

#### **5.3.6 History Inspection:**

**[Periodical Maintenance]** Analysis the history record to check has accident (alarm and protection) or not, and analysis its reason.

#### **5.3.7 Shutdown and Maintenance:**

##### **[Periodical Maintenance]**

Some system function must be maintenance during the EMS restart, it is recommended to maintenance the system every 6 months.

#### **5.3.8 Recycle**

##### **NOTE**

Damaged batteries may leak electrolyte or produce flammable gas.

In case a damaged battery needs recycling, it shall follow the local recycling regulation (ie. Regulation (EC) N° 1013/2006 among European Union) to process, and using the best available techniques to achieve a relevant recycling efficiency.

## 6. Storage Recommendations

b) For long-term storage (more than 3 months), the battery cells should be stored in the temperature range of 5~45°C, relative humidity <65% and contains no corrosive gas environment.

The battery module should shelved in range of 5~45°C, dry, clean and well ventilated environment. Before storage the battery should be charged to 50~55% SoC;

It is recommended to active the chemical (discharge and charge) of the battery every 3 months, and the longest discharge and charge interval shall not exceed 6 months.



Caution: If not follow the above instructions for long term store the battery, The cycle life will have relative heavily reduction.

## 7. Shipment

Battery module will pre-charged to 100%SOC or according to customer requirement before shipment. The remaining capacity of battery cell, after shipment and before charge, is determined by the storage time and condition.

1. The battery modules meet the UN38.3 certificate standard.
2. In particular, special rules for the carriage of goods on the road and the current dangerous goods law, specifically ADR (European Convention on the International Carriage of Dangerous Goods by Road), as amended, must be observed.

Any further qDuestions, please contact Pylontech: [service@pylontech.com.cn](mailto:service@pylontech.com.cn)

## Annex 1: Installation and System Turn ON Progress List

Tick after completion	No.	Item	Remark
<input type="checkbox"/>	1	The environment is meeting all technical requirements. 3.3.1 Cleaning 3.3.2 Temperature 3.3.3 Radiating System 3.3.4 Heating System 3.3.5 Fire-extinguisher System 3.3.6 Grounding System	Refer to chapter 3.3
<input type="checkbox"/>	2	Selection of installation sites.	Refer to chapter 3.4.3.
<input type="checkbox"/>	3	Battery base is installed follow the technical requirements.	Refer to chapter 3.4.4.
<input type="checkbox"/>	4	Battery modules installation.	Refer to chapter 3.4.5.
<input type="checkbox"/>	5	Battery system are fixed.	Refer to chapter 3.4.6.
<input type="checkbox"/>	6	Control Module (BMS) and Battery Module are installed well.	Refer to chapter 3.4.7.
<input type="checkbox"/>	7	Connect <b>D+ and D-</b> between BMS to the inverter/PCS or confluence cabinet.	Refer to chapter 3.5.2.
<input type="checkbox"/>	8	Connect the grounding cable.	Refer to chapter 3.5.1.
<input type="checkbox"/>	9	Double check every <b>power cables, communication cables, grounding cable</b> installed well.	Refer to chapter 3.5.2 and 3.5.1.
<input type="checkbox"/>	10	Switch the external power or inverter/PCS on, ensure all the power equipment can work normally.	Refer to chapter 3.6.4.

<input type="checkbox"/>	11	The first installation should do full charging progress automatically. If the status LED of BMS turns to blue, it means this battery string is operation.	
--------------------------	----	--	--

### Annex 2: System Turn OFF Progress List

Tick after completion	No.	Item	Remark
<input type="checkbox"/>	1	Soft-off the inverter through inverter's control panel.	Refer to chapter 3.5.4.
<input type="checkbox"/>	2	Turn off the switch between inverter and this battery string (Force-H2), or turn off the power switch of inverter, to make sure no current through this battery string.	Refer to chapter 3.5.4.
<input type="checkbox"/>	3	Turn off the "Power Switch" of the BMS.	Refer to chapter 3.5.4.





**PYLONTECH**

**Pylon Technologies Co., Ltd.**

No. 73, Lane 887, ZuChongzhi Road, Zhangjiang Hi-Tech Park

Pudong, Shanghai 201203, China

**T** +86-21-51317699 | **F** +86-21-51317698

**E** [service@pylontech.com.cn](mailto:service@pylontech.com.cn)

**W** [www.pylontech.com.cn](http://www.pylontech.com.cn)